

# Stretcher and hanging bars

M O L G R A C O L L E C T I O N

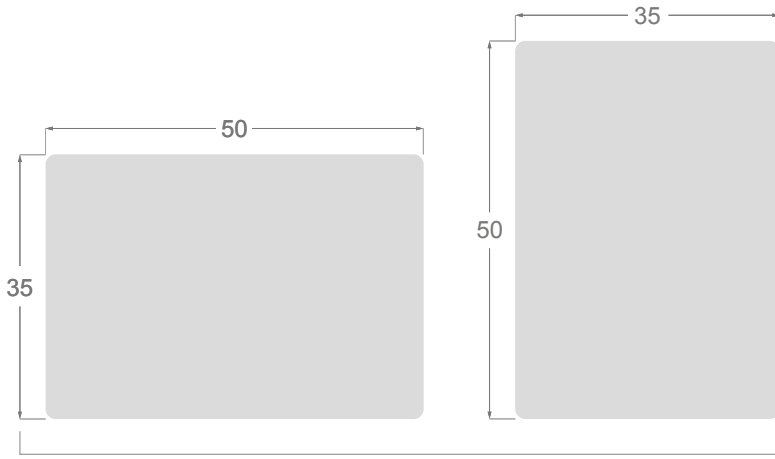

# Stretcher and hanging bars in finger-jointed pinewood



**1757/000** Bastidor reversible

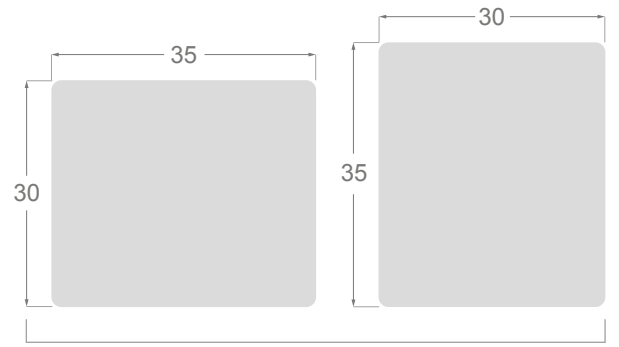

**1753/000** Bastidor reversible

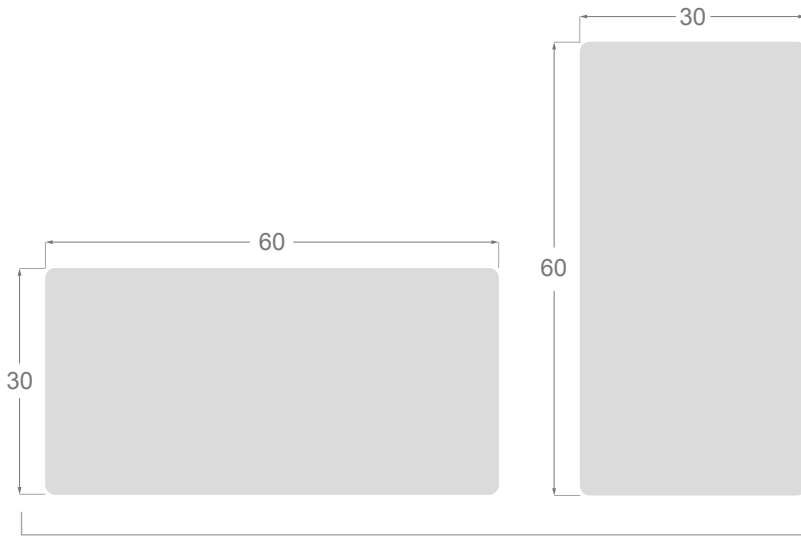

**1759/000** Bastidor reversible

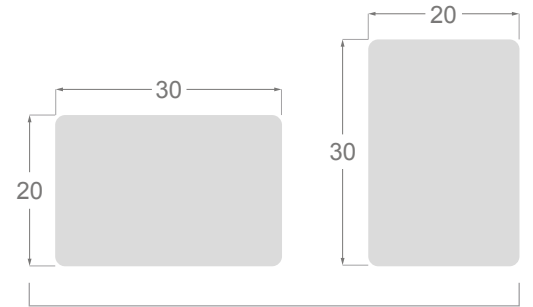

**1752/000** Bastidor reversible

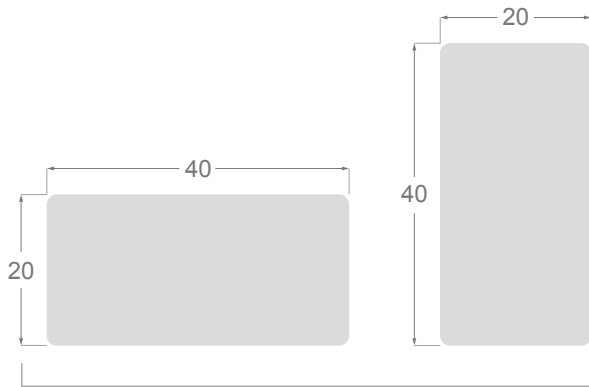

**1755/000** Bastidor reversible

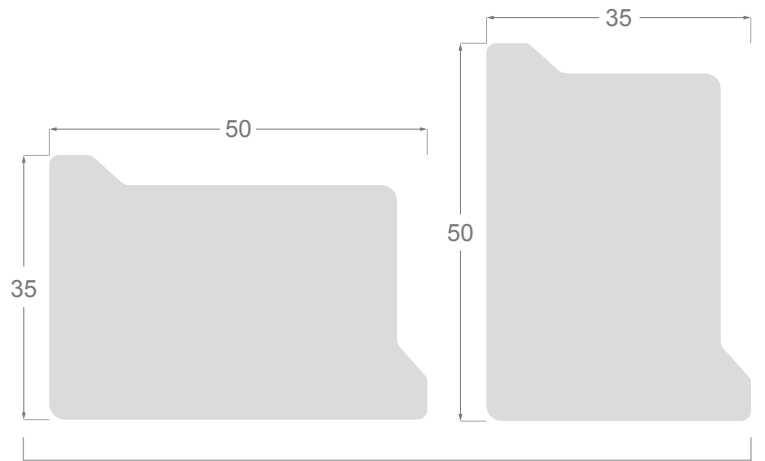

**1777/000** Bastidor reversible

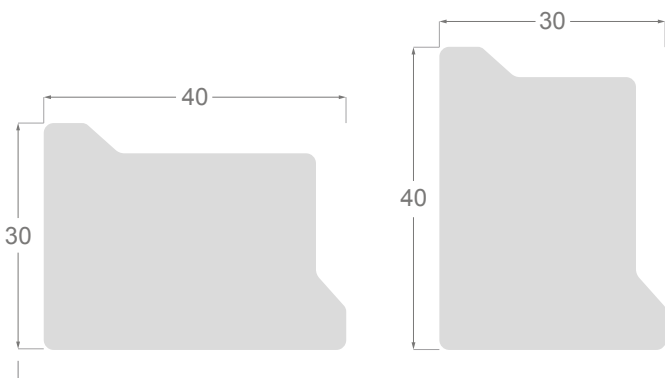

**1776/000** Bastidor reversible

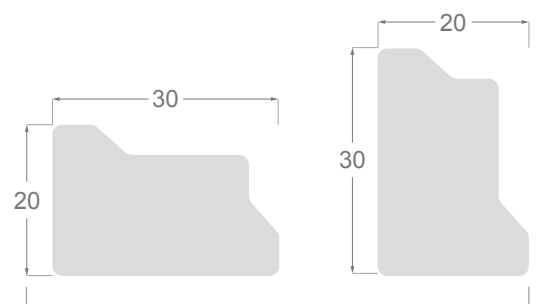

**1775/000** Bastidor reversible

## Stretcher and hanging bars in finger-jointed pinewood

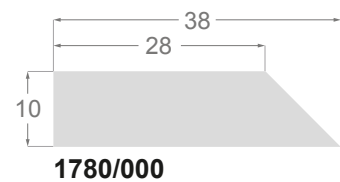
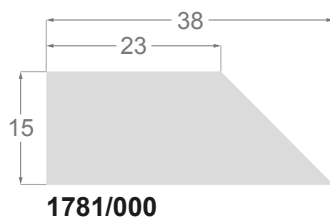
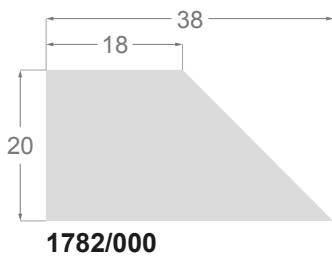
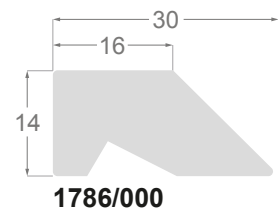
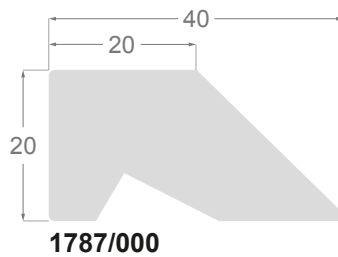
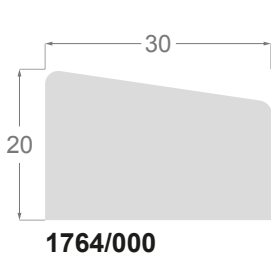
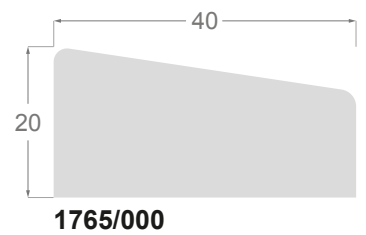
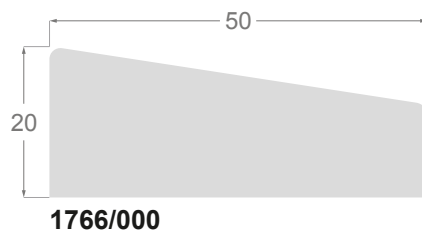
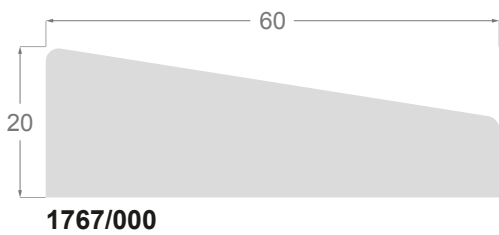
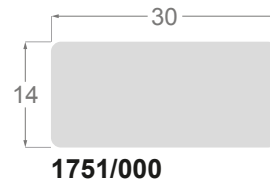
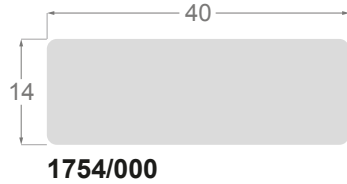
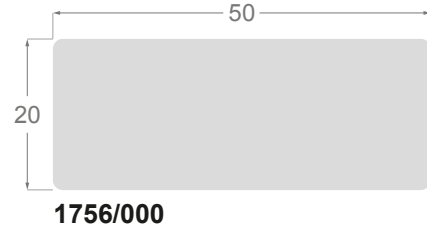
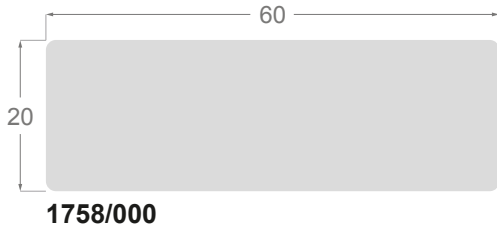

## Ayous stretcher bars

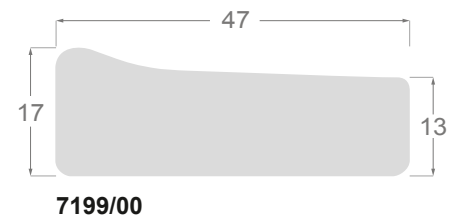
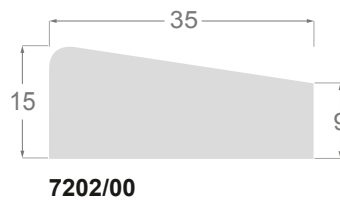
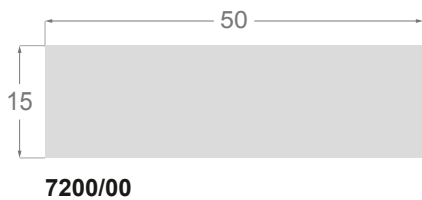
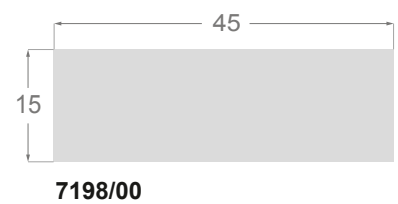
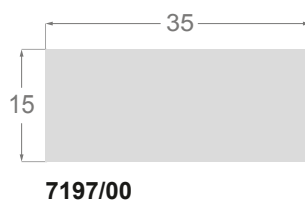
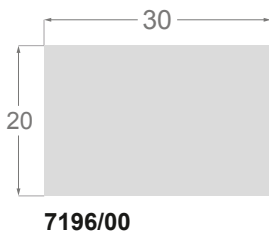

*Stretchers bars in finger-jointed pinewood*

**1759/000** 60x30mm - Reversible (30x60mm)



**1758/000** 60x20mm



**1757/000** 50x35mm - Reversible (35x50mm)



**1756/000** 50x20mm





*Stretcher bars in finger-jointed pinewood*

**1755/000** 40x20mm - Reversible (20x40mm)



**1754/000** 40x14mm



**1753/000** 35x30mm - Reversible (30x35mm)



**1752/000** 30x20mm - Reversible (20x30mm)



**1751/000** 30x14mm



*Stretcher bars in finger-jointed pinewood*

**1767/000** 60x20mm



**1766/000** 50x20mm



**1765/000** 40x20mm



**1764/000** 30x20mm



*Stretchers bars in finger-jointed pinewood*

**1777/000** 50x35mm - Reversible (35x50mm)



**1776/000** 40x30mm - Reversible (30x40mm)



**1775/000** 30x20mm - Reversible (20x30mm)





*Ayous hanging bars*

**7199/00** 47x17mm



**7200/00** 50x15mm



**7198/00** 45x15mm



**7202/00** 35x15mm



**7197/00** 35x15mm



**7196/00** 30x20mm





## Stretcher bars in finger-jointed pinewood

1782/000 38x20mm



1781/000 38x15mm



1780/000 38x10mm

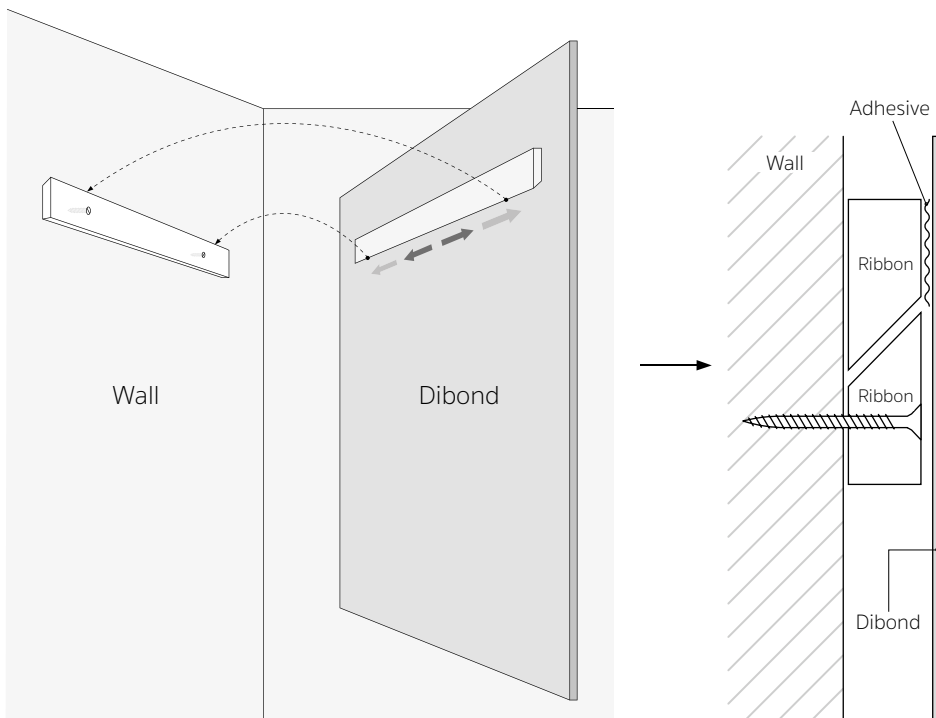

Ribbons specially designed to hang sheets of Dibond or other materials, separated from the wall.

Its wedge shape achieves the total adjustment of the works to the surface of the wall in an easy way, applying several possible assemblies.

## Stretcher bars in finger-jointed pinewood

**1787/000** 40x20mm



**1786/000** 30x14mm



Stretcher bars in finger-jointed pinewood, specially designed to easily hang any picture or frame on the wall. The shape of the profile, with its inclined interior channel, allows the strip to be screwed, nailed or stapled to the molding on the back of the picture, thus giving narrow moldings greater resistance on the hanging side.

We attach a cross-sectional photomontage, showing an example. Attached to the picture, the strip with its pronounced lower bevel allows a perfect fit on the hooks or screws placed on the wall, keeping the picture totally vertical, in this way we can move the picture to the right or left according to convenience, without making new holes. It is served in individual strips of approximately 3 meters.

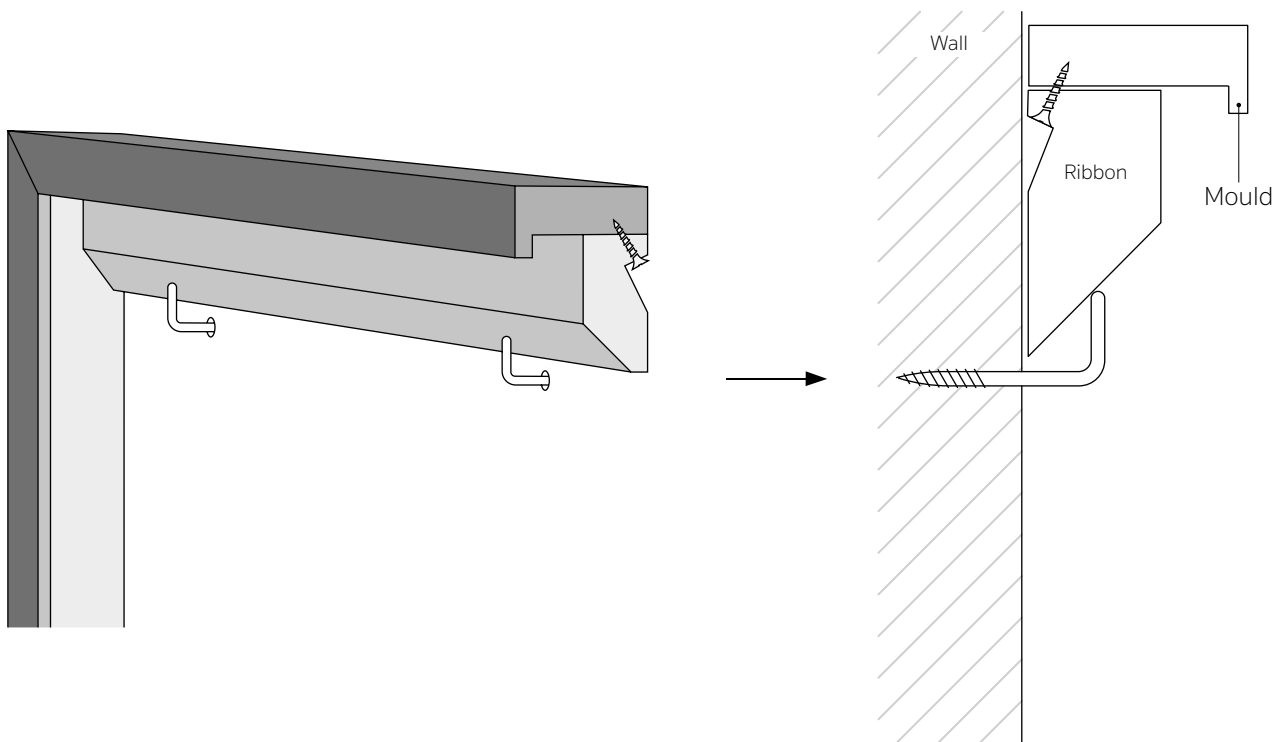





[www.molgra.com](http://www.molgra.com)



Av. de Cervera 16  
25300 TÀRREGA (LLEIDA) Spain  
Tel. +34 973 312 304  
[comercial@molgra.com](mailto:comercial@molgra.com)