

Bastidores y listones para colgar

M O L G R A C O L L E C T I O N

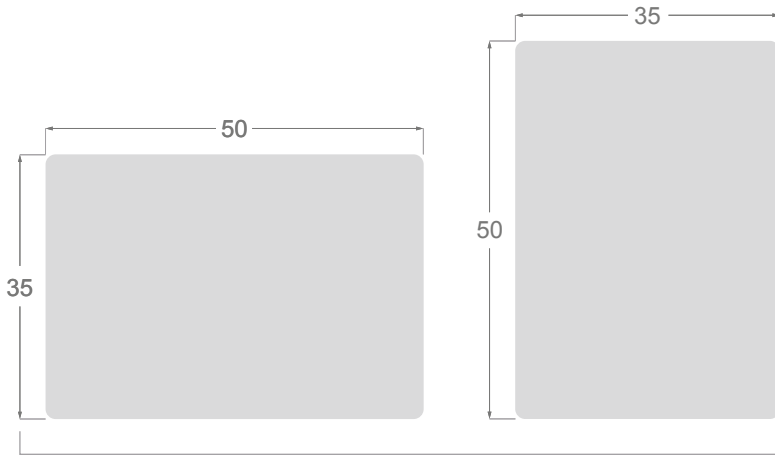

Bastidores y listones para colgar de pino finger



1757/000 Bastidor reversible

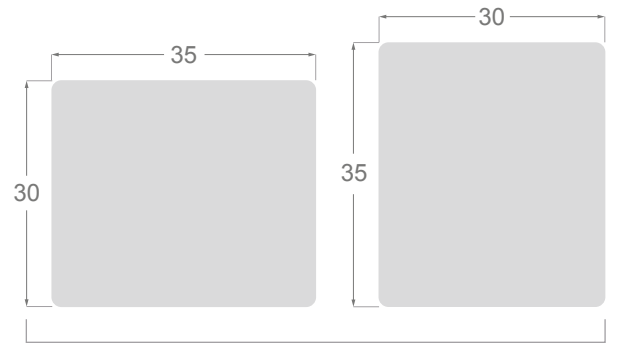

1753/000 Bastidor reversible

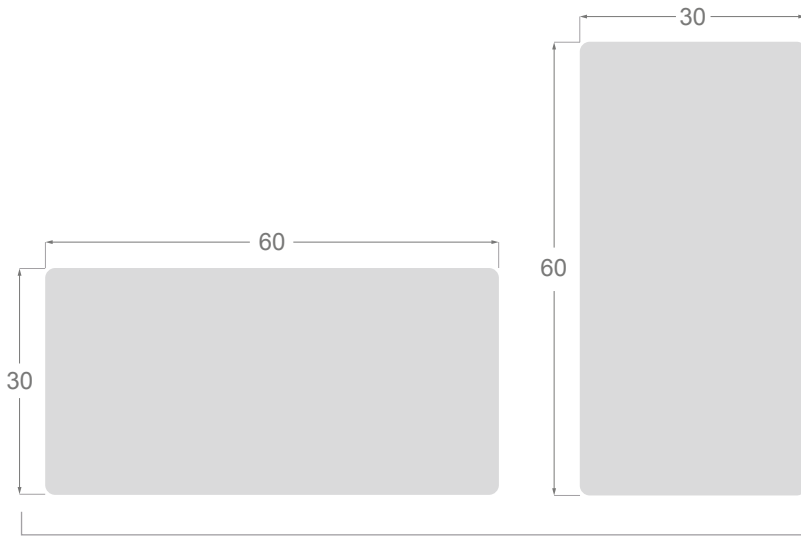

1759/000 Bastidor reversible

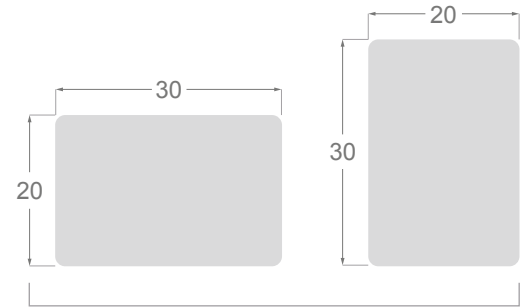

1752/000 Bastidor reversible

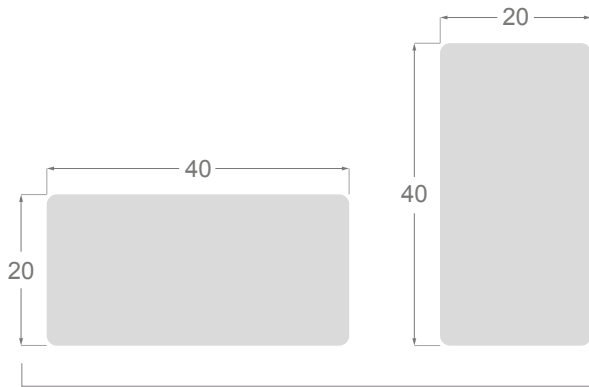

1755/000 Bastidor reversible

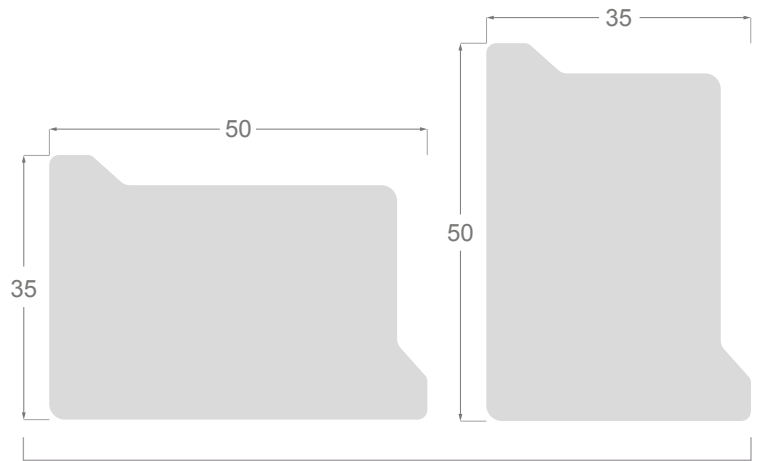

1777/000 Bastidor reversible

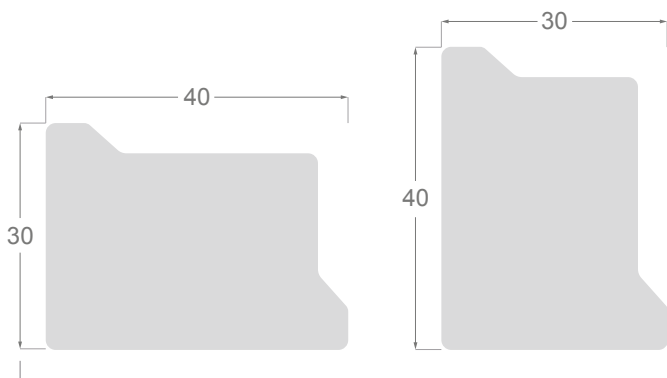

1776/000 Bastidor reversible

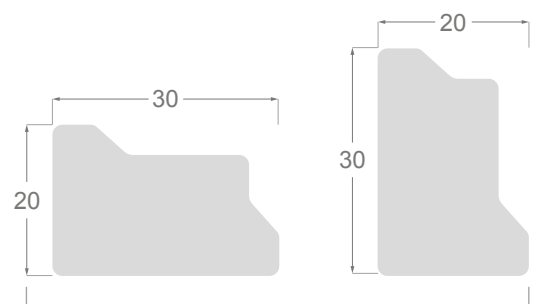

1775/000 Bastidor reversible

Bastidores y listones para colgar de pino finger

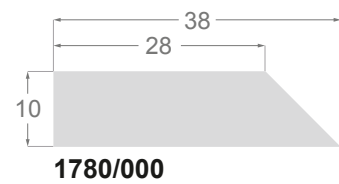
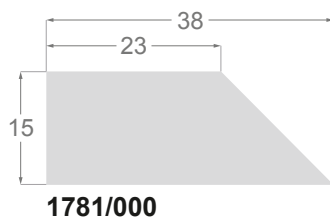
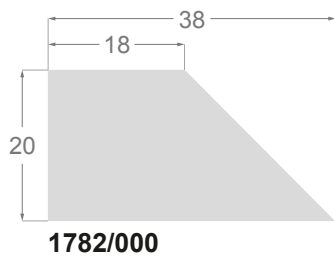
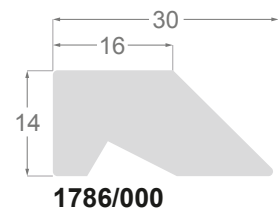
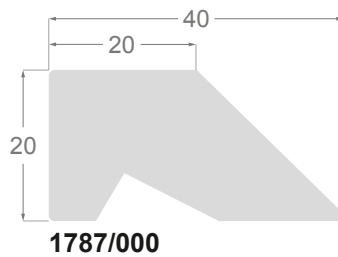
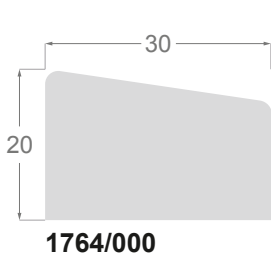
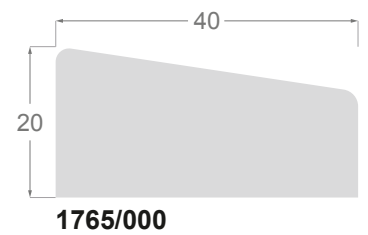
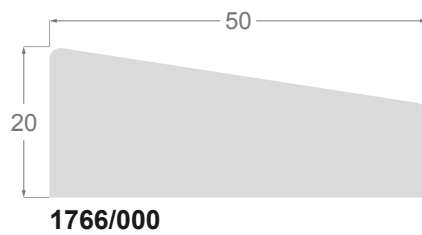
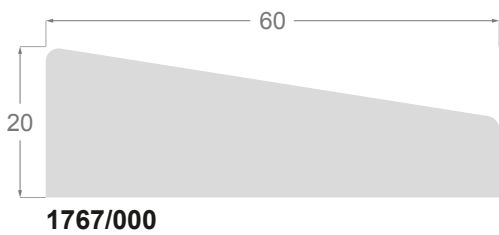
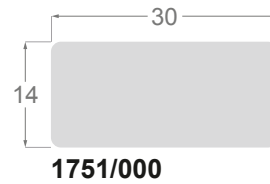
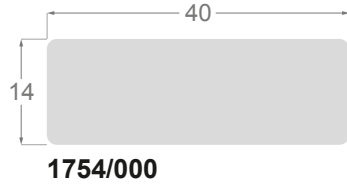
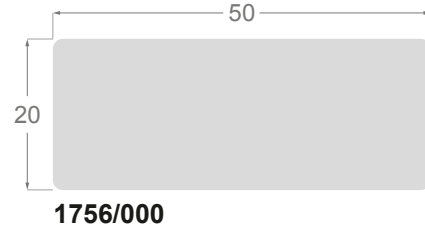
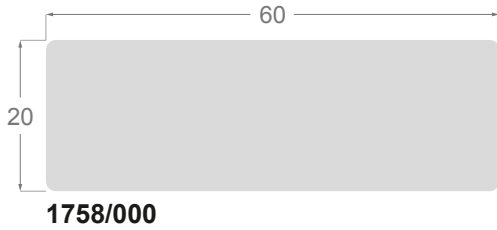

Bastidores y listones en ayous

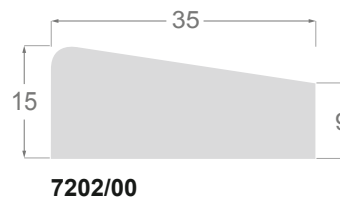
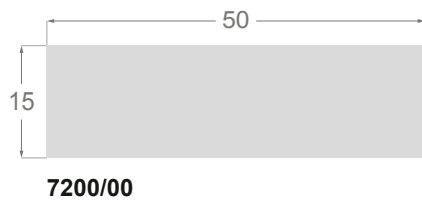
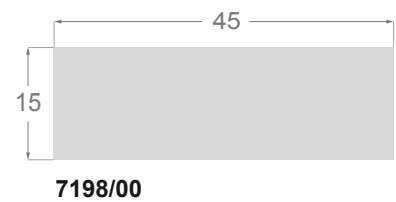
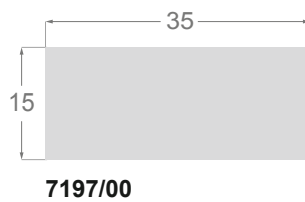
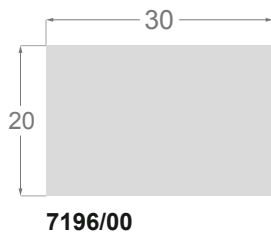

Bastidores pino finger

1759/000 60x30mm - Reversible (30x60mm)



1758/000 60x20mm



1757/000 50x35mm - Reversible (35x50mm)



1756/000 50x20mm



Bastidores pino finger

1755/000 40x20mm - Reversible (20x40mm)



1754/000 40x14mm



1753/000 35x30mm - Reversible (30x35mm)



1752/000 30x20mm - Reversible (20x30mm)



1751/000 30x14mm



Listones de pino finger para colgar

1767/000 60x20mm



1766/000 50x20mm



1765/000 40x20mm



1764/000 30x20mm



Bastidores pino finger

1777/000 50x35mm - Reversible (35x50mm)



1776/000 40x30mm - Reversible (30x40mm)



1775/000 30x20mm - Reversible (20x30mm)



Bastidores de ayous

7200/00 50x15mm



7198/00 45x15mm



7202/00 35x15mm



7197/00 35x15mm



7196/00 30x20mm



Bastidores pino finger

1782/000 38x20mm



1781/000 38x15mm



1780/000 38x10mm

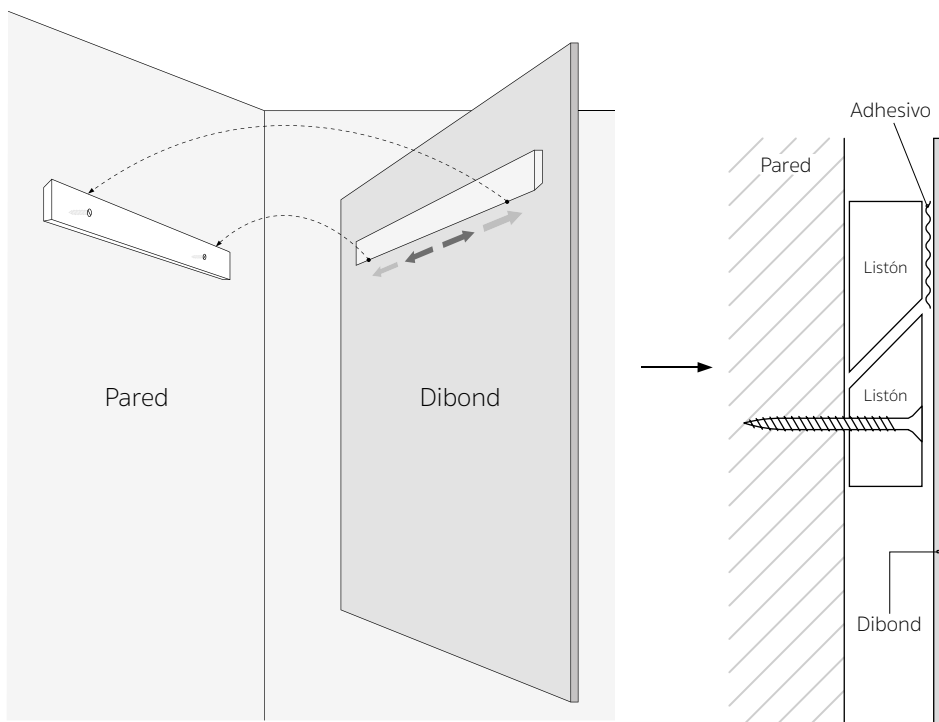

Bastidores especialmente diseñados para colgar láminas de Dibond o de otros materiales, separadas de la pared.

Su forma de cuña consigue el ajuste total de las obras a la superficie del muro de forma fácil, aplicando varios posibles montajes.

Bastidores pino finger

1787/000 40x20mm



1786/000 30x14mm



Listón de pino finger, especialmente diseñado para colgar en la pared cualquier cuadro o bastidor con facilidad. La forma del perfil, con su canal interior inclinado permite atornillar, clavar o grapar el listón a la moldura por la parte trasera del cuadro, dándole así una mayor resistencia a las molduras estrechas por el lado que se cuelga.

Adjuntamos un fotomontaje en corte transversal, mostrando un ejemplo. Unido al cuadro, el listón con su bisel inferior pronunciado permite un encaje perfecto sobre las alcayatas o tornillos colocados en la pared, manteniendo el cuadro totalmente vertical, de esta manera podemos desplazar el cuadro a derechas o izquierdas según conveniencia, sin hacer agujeros nuevos. Se sirve en tiras individuales de aproximadamente 3 metros.

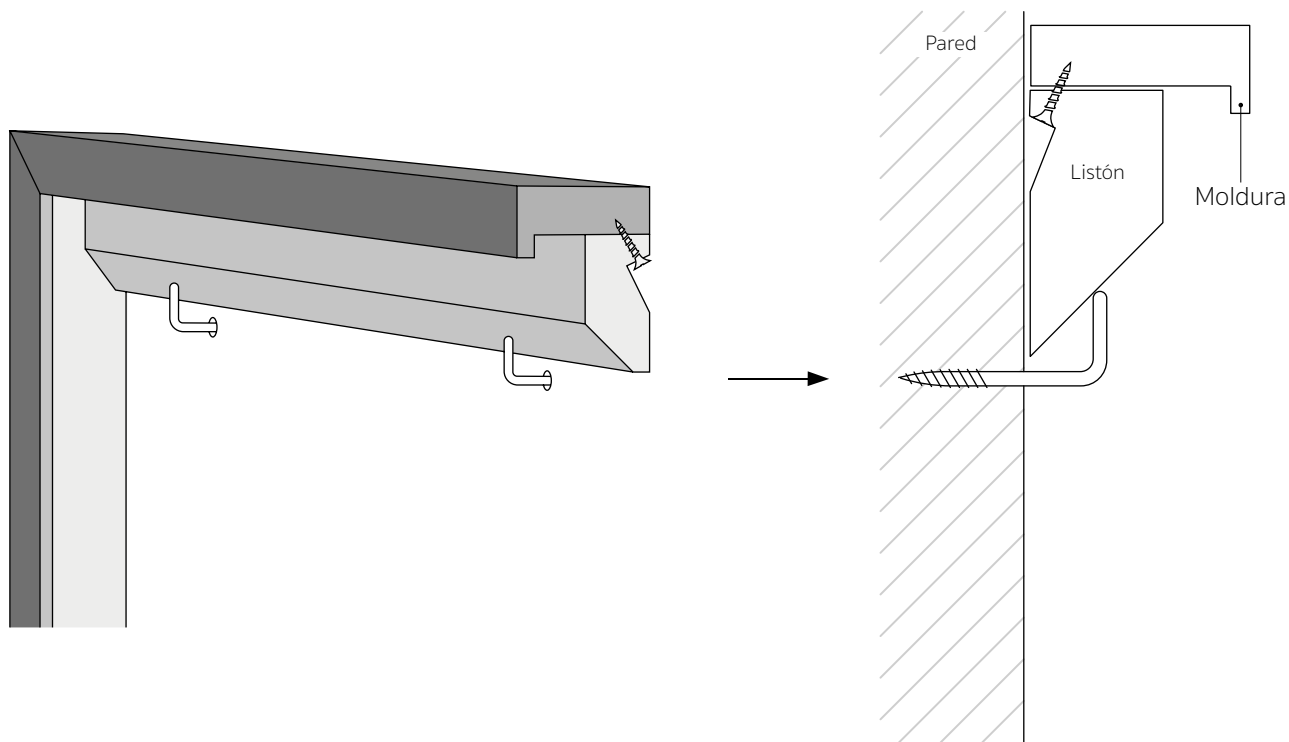



www.molgra.com



Av. de Cervera 16
25300 TÀRREGA (LLEIDA) Spain
Tel. +34 973 312 304
comercial@molgra.com